

www.tz.newmatic.com

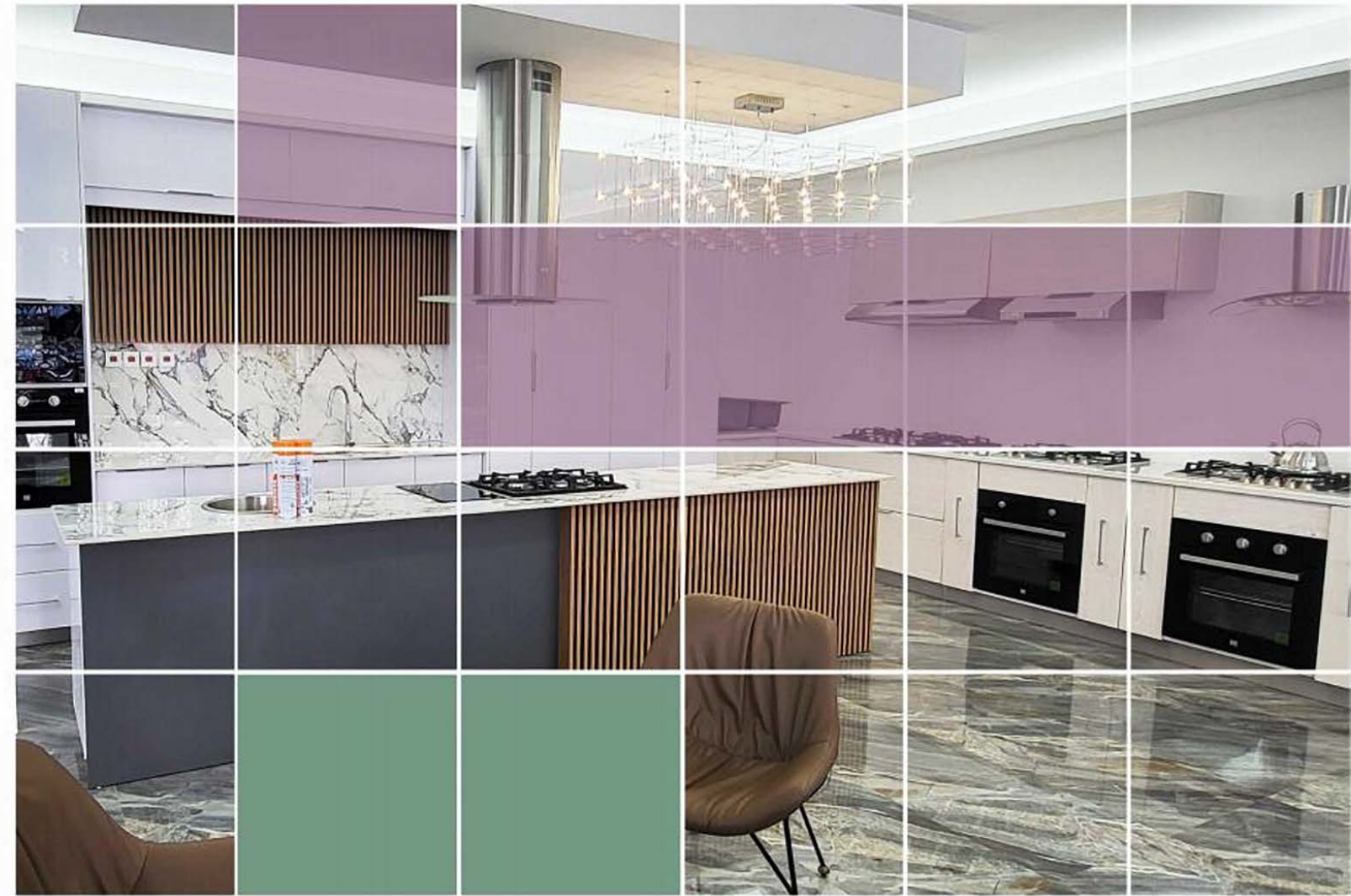

2023 East Africa Collection

Newmatic

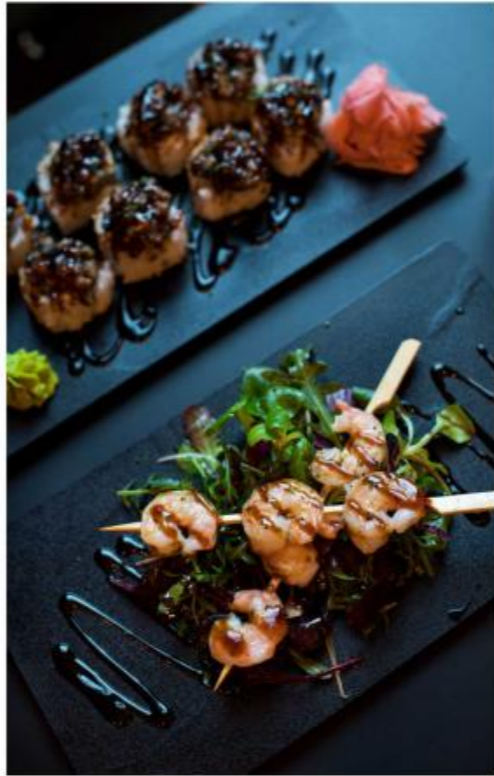

NEWMATIC COLLECTION

PRO SERIES	01
RANGE HOOD	07
COOKTOP	13
ELECTRIC OVEN	21
KITCHEN SINK	27
KITCHEN TAP	35
KITCHEN HARDWARE	37
COUNTER TOP	47
SPLASH BACK	49
BUILDER SERIES	51
CONTACT	55



Newmatic

PRO SERIES

DESIGNED IN SINGAPORE 



Voice & Smart Gesture Control

Wave your hand to make things happen



- Power on
- OK, I'm working now
- Light on
- OK, Lights on
- Power off
- OK, Goodbye
- Light off
- OK, Lights off
- Speed four
- OK, Speed four
- Delay shutdown
- OK, shutdown 3 mins later





H66.9V-PRO

INTELLIGENT CONTROL WALL HOOD

Features

- 90cm T-shaped chimney hood
- Intelligent control
- 5 layers washable aluminum grease filters
- Charcoal filter

Specifications

- Lighting: Strip LED lamp 2x2W
- Motor input power: 138W
- Air flow: 760m³/h
- Outlet diameter: φ150mm
- Noise level: ≤58dB(A)



FM6133T-PRO

BUILT IN ELECTRIC OVEN

A+



Product Features

- 75L built-in multifunction oven
- Grill & Air fryer
- Touch control with LED display
- Energy class A+
- 96 mm height control panel
- Forced cooling system
- Full glass inner door
- Triple coated glass door
- Total power 2900W
- 220V 50Hz
- Enamel baking tray
- Grill rack

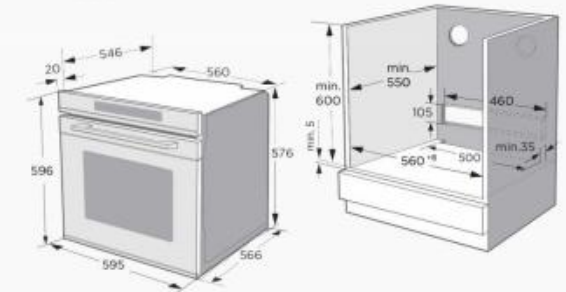

32EPS-PRO

BUILT IN MICROWAVE OVEN

Product Features

- 32L Built-in microwave oven
- Touch control Panel
- Microwave & Grill function
- Stainless steel cavity
- Full black with slim handle
- LED Display

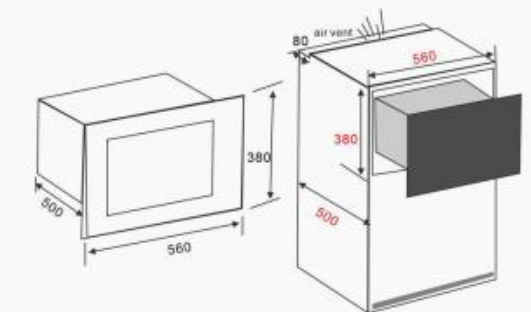

NEW ARRIVAL

NEW ARRIVAL



iStock
Credit: nitrub

Newmatic
2 in 1
COOKERTOP
NEW ARRIVAL

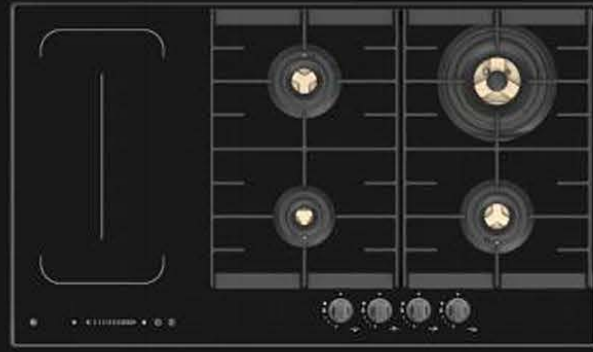

- Designed in Singapore, the PRO SERIES brings elegance and high performance to your kitchen.
- Built with top-grade materials and cutting-edge techniques, this stove redefines excellence.
- Experience cooking that's efficient, yet effortlessly smooth.
- Beyond performance, its aesthetics are a revolutionary blend of sleek lines and premium colors.



SUS304

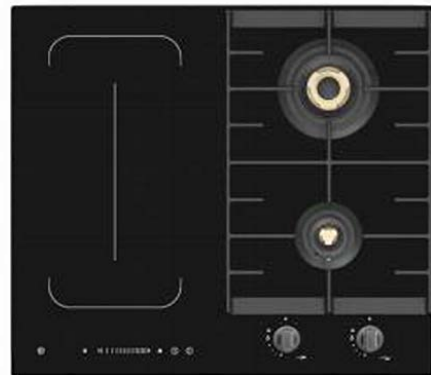

60cm Built-in Gas & Induction hob

PM622FC-PRO

- Features**
 Full ceramic glass
 Full brass burner
 Heavy duty cast iron trivets
 Auto-ignition by electricity
 Flame failure device (FFD)
 Zinc alloy knobs & spacer
 Sensor touch control
 9-stage adjustable cooking power
 99-minute digital timer
 Residual heat indicator
 Child safety lock
 Boost function; Keep warm; Stop & go

- Specifications**
 Gas type: LPG
 Front left: ϕ 180mm, 1500 / 1800W
 Rear left: ϕ 180mm, 2000 / 2300W
 Flex zone: 2500/2800W
 1 x Rapid burner: 2.4kW
 1 x Auxiliary burner: 1.0kW

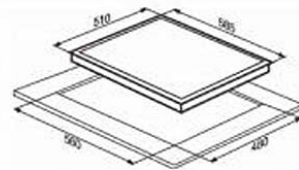

60cm Built-in Gas Hob

PM640STX-PRO

- Features**
 304 stainless steel top panel
 Heavy duty cast iron trivets
 Battery ignition(1.5V)
 Flame failure device (FFD)
 Zinc alloy knobs

- Specifications**
 Gas type: LPG
 Rated Heat:
 1x Triple ring burner 4kW
 Semi-rapid burner 1.8kW
 Auxiliary burner 1.0kW

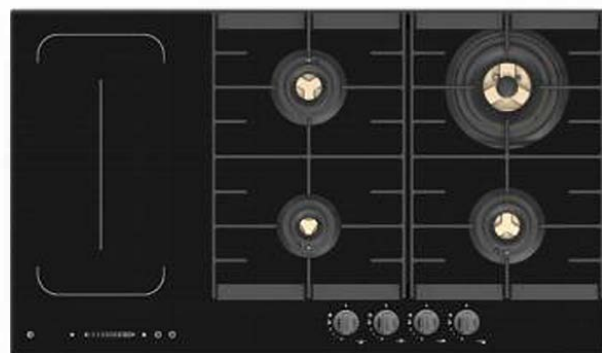
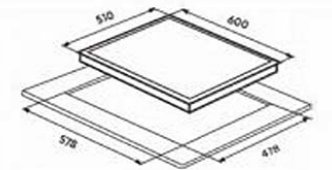

90cm Built-in Gas & ceramic hob

PM942FC-PRO

- Features**
 Full ceramic glass
 Full brass burner
 Heavy duty cast iron trivets
 Auto-ignition by electricity
 Flame failure device (FFD)
 Zinc alloy knobs & spacer
 Sensor touch control
 9-stage adjustable cooking power
 99-minute digital timer
 Residual heat indicator
 Child safety lock
 Boost function; Keep warm; Stop & go

- Specifications**
 Gas type: LPG
 Front left: ϕ 180mm, 1500 / 1800W
 Rear left: ϕ 180mm, 2000 / 2300W
 Flex zone: 2500/2800W
 1 x Wok burner: 3.8kW
 2 x Semi-rapid burner: 1.5kW
 1 x Auxiliary burner: 1.0kW

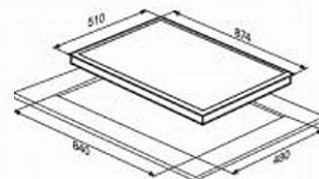

90cm Built-in Gas Hob

PM950STX-PRO

- Features**
 304 stainless steel top
 Heavy duty cast iron trivets
 Battery ignition(1.5V)
 Flame failure device (FFD)
 Zinc alloy knobs

- Specifications**
 Gas type: LPG
 Rated Heat:
 1 x Triple ring burner 3.4kW
 1 x Rapid burner 2.4kW
 2x Semi-rapid burner 1.8kW
 1 x Auxiliary burner 1.0kW

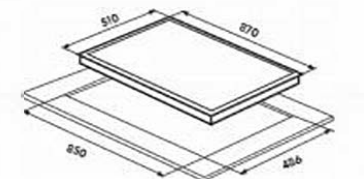



RANGE HOOD COLLECTION

Newmatic



BENEFITS



SAFETY
Expels dangerous combustion fume outdoors to ensure the safety of occupants



HEALTHY ENVIRONMENT
Exhaust from fuel combustion & vapor from food ingredients may be carcinogenic. They should be expelled from the kitchen promptly



ENERGY SAVING
To conserve previous energy resources, all NEWMATIC hoods are equipped with LED lamps. Strip LED light with SMT has especially nice color, good lumen, spread & will last 35,000 hours.



MOTOR 5 YEARS WARRANTY
Fully metallic motor that is powerful & durable



TEMPERED GLASS LIFETIME WARRANTY
Safety & resilience is assured by the highest quality tempered glass material



90cm Tempered Glass & Stainless Steel Range Hood

H77.9P

Features
90cm glass wall hood
3 speed push button control
5 layers washable aluminum grease filters

Specifications
Lighting: LED lamp 2x1.5W
Motor input power: 138W
Air flow: 760m³/h
Outlet diameter: ϕ 150mm
Noise level: \leq 58dB(A)



60cm Stainless Steel Wall Hood

H64.6S

Features
60cm stainless steel T-shaped wall hood
3 speed touch control with delay timer
5 layers washable aluminum grease filters
Easy to clean glass control panel

Specifications
Lighting: LED lamp 2x1.5W
Motor input power: 138W
Air flow: 760m³/h
Outlet diameter: ϕ 150mm
Noise level: \leq 58dB(A)



90cm Tempered Glass & Black Painted Wall Hood

H77.9PB

Features
90cm glass wall hood
3 speed push button control
5 layers washable aluminum grease filters

Specifications
Lighting: LED lamp 2x1.5W
Motor input power: 138W
Air flow: 760m³/h
Outlet diameter: ϕ 150mm
Noise level: \leq 58dB(A)



90cm Stainless Steel Wall Hood

H64.9S

Features
90cm stainless steel T-shaped wall hood
3 speed touch control with delay timer
5 layers washable aluminum grease filters
Easy to clean glass control panel

Specifications
Lighting: LED lamp 2x1.5W
Motor input power: 138W
Air flow: 760m³/h
Outlet diameter: ϕ 150mm
Noise level: \leq 58dB(A)



90cm Tempered Glass & Stainless Steel Wall Hood

H76.9S

Features
90cm curved glass wall hood
3 speed touch control with delay timer
5 layers washable aluminum grease filters

Specifications
Lighting: Strip LED lamp 2x2W
Motor input power: 138W
Air flow: 760m³/h
Outlet diameter: ϕ 150mm
Noise level: \leq 58dB(A)



90cm Tempered Glass Robotic Wall Hood

H86.9S

Features
90cm robotic wall hood
3 speed touch control with delay timer
5 layers washable aluminum grease filters
Charcoal filters are included

Specifications
Lighting: Strip LED lamp 2x1.5W
Motor input power: 220W
Air flow: 900m³/h
Outlet diameter: ϕ 150mm
Noise level: \leq 58dB(A)

WALL HOOD

WALL HOOD



SLIM HOOD

The Newmatic Slim Hood using dual AC motors saves you up to 50% electricity compared to other hoods of similar performance. The fully welded chassis is stylish & robust.



90cm Stainless Steel Island Hood

H97.9S

Features
 90cm glass island hood
 3 speed touch control with delay timer
 5 layers washable aluminum grease filters
 Easy to clean glass control panel
 Stainless steel seamless chimney

Specifications
 Lighting: LED lamp 2x2W
 Motor input power: 138W
 Air flow: 760m³/h
 Outlet diameter: ϕ 150mm
 Noise level: \leq 58dB(A)



90cm Stainless Steel Island Hood

H94.9S

Features
 90cm stainless steel T-shaped island hood
 3 speed touch control with delay timer
 5 layers washable aluminum grease filters
 Easy to clean glass control panel

Specifications
 Lighting: LED lamp 4x1.5W
 Motor input power: 138W
 Air flow: 760m³/h
 Outlet diameter: ϕ 150mm
 Noise level: \leq 58dB(A)

ISLAND HOOD



60cm Stainless Steel Recirculating Slim Hood



H18.6S

Features
 60cm stainless steel under cabinet hood
 3 speed touch control with delay timer
 3 layers washable aluminum grease filters
 Recirculating hood with charcoal filter

Specifications
 Lighting: LED lamp 2x1.5W
 Motor input power: 100W
 Air flow: 550m³/h
 Outlet diameter: ϕ 125mm
 Noise level: \leq 58dB(A)



90cm Stainless Steel Recirculating Slim Hood



H18.9S

Features
 90cm stainless steel under cabinet hood
 3 speed touch control with delay timer
 3 layers washable aluminum grease filters
 Recirculating hood with charcoal filter

Specifications
 Lighting: LED lamp 2x1.5W
 Motor input power: 100W
 Air flow: 550m³/h
 Outlet diameter: ϕ 125mm
 Noise level: \leq 58dB(A)

NEWMATIC BUILT-IN HOB



SUS 304
COOKTOP COLLECTION
Enjoy Cooking Time

A Symphony of East & West

NEWMATIC gas hobs are designed & manufactured to meet European specifications. The configurations, dimensions & safety levels are based on British standards. At the same time, the cook tops meet the demand of the African kitchen for robustness & fuel gas savings.



When conducted indoors, gas cooking rapidly reduces the oxygen level in the kitchen. Ensure goods & permanent ventilation at all times for your health & safety. It is also advisable for this reason to operate your range hood in the ducted mode whenever possible.

Zinc Alloy Knobs And Spacer

Zinc Alloy Knobs are superior to plastic knobs in resisting heat stress and aging. The spacer prevents foreign objects from entering the hob. Finished to a champagne color, these knobs are both luxurious and durable.



Flame Failure Device

The FFD automatically shuts off the gas should the flame be accidentally extinguished. The Mikuni FFD is exceptionally fast acting. Equipped with individual earthen point for extra reliability in a greasy environment.

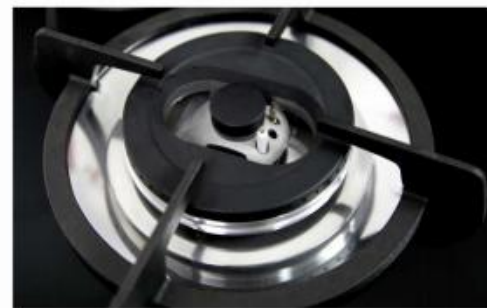

Tempered Glass Top

The tempered glass top is easy to clean and stays flawless even after years of use. Tested to Singapore SS72 & Australia AG 101, the glass material carries a factory life time warranty for complete peace of mind.



Cast Iron Trivets

As in commercial cooking equipment, NEWMATIC built-in hobs are equipped, as standard, with heavy cast iron trivets for reliability & safety. You can cook with larger & heavy pots in complete confidence.





90cm Built-in Gas Hob

PM950STX

Features
 304 stainless steel top
 Heavy duty cast iron trivets
 Battery ignition(1.5V)
 Flame failure device (FFD)
 Zinc alloy knobs & spacer

Specifications
 Gas type: LPG
 Rated Heat:
 1 x Triple ring burner 3.4kW
 1 x Rapid burner 2.4kW
 2 x Semi-rapid burner 1.8kW
 1 x Auxiliary burner 1.0kW



60cm Built-in Gas Hob

PM640STX-N

Features
 304 stainless steel top panel
 Heavy duty cast iron trivets
 Battery ignition(1.5V)
 Flame failure device (FFD)
 Zinc alloy knobs & spacer

Specifications
 Gas type: LPG
 Rated Heat:
 1 x Triple ring burner 3.4kW
 2 x Semi-rapid burner 1.8kW
 1 x Auxiliary burner 1.0kW

90CM



90cm Built-in Gas Hob

PM950STGB

Features
 8mm tempered glass top with lifetime warranty
 Heavy cast iron pan support
 Flame failure device (FFD)
 Battery ignition (1.5V)
 Zinc alloy knobs & spacer

Specifications
 Gas type: LPG
 Rated Heat:
 1 x Triple ring burner 3.4kW
 1 x Rapid burner 2.4kW
 2 x Semi-rapid burner 1.8kW
 1 x Auxiliary burner 1.0kW



58cm Built-in Gas Hob

PM640STGB

Features
 8mm tempered glass top with lifetime warranty
 Heavy cast iron pan support
 Sabaf burner, with flame failure device (FFD)
 Battery ignition (1.5V)
 Zinc alloy knob&spacer

Specifications
 Gas type: LPG
 Rated Heat:
 1 x Triple ring burner 3.4kW
 2 x Semi-rapid burner 1.8kW
 1 x Auxiliary burner 1.0kW

60CM



90cm Built-in Gas & Ceramic Hob

PM941VSTGB

Features
 8mm tempered glass top with lifetime warranty
 Heavy cast iron pan support
 Auto-ignition by electricity
 Flame failure device (FFD)
 Zinc alloy knobs & spacer
 Residual heat indicator
 9 levels of radiant power

Specifications
 Gas type: LPG
 Rated Heat:
 1 x Triple ring burner 3.4kW
 1 x Rapid burner 2.4kW
 1 x Semi-rapid burner 1.8kW
 1 x Auxiliary burner 1.0kW
 1 x Ceramic hob (φ145mm,1200kW)



60cm Built-in Gas & Ceramic Hob

PM631VSTGB

Features
 8mm tempered glass top with lifetime warranty
 Heavy cast iron pan support
 Auto-ignition by electricity
 Flame failure device (FFD)
 Zinc alloy knobs & spacer
 Residual heat indicator
 9 levels of radiant power

Specifications
 Gas type: LPG
 Rated Heat:
 1 x Triple ring burner 3.4kW
 1 x Semi-rapid burner 1.8kW
 1 x Auxiliary burner 1.0kW
 1 x Ceramic hob (φ145mm,1200W)

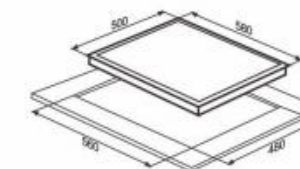
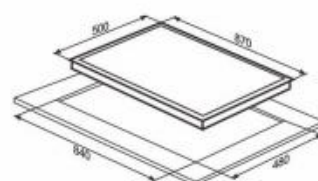

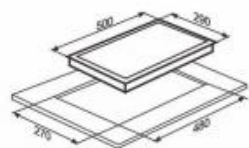

30cm Built-in Gas Hob

PM320SX

- Features**
 304 stainless steel top
 Heavy duty cast iron trivets
 Battery ignition(1.5V)
 Flame failure device (FFD)
 Zinc alloy knobs & spacer

- Specifications**
 Gas type: LPG
 Rated Heat:
 1x Rapid burner 2.4kW
 2x Semi-rapid burner 1.8kW

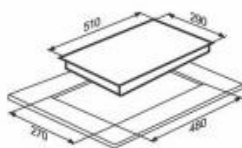

30cm Built-in Induction Cooker Hob

PM302I

- Features**
 Sensor touch control
 9-stage cooking power setting
 99-minute digital timer
 Child safety lock
 Residual heat indicator
 Boost function

- Specifications**
 Total power 3500W:
 Front: ϕ 160mm, 1500/1800W (Boost)
 Rear: ϕ 180mm, 2000/2300W (Boost)

60\30CM



60cm Built-in Induction Cooker Hob

PM604I

- Features**
 Sensor touch control
 9-stage cooking power setting
 99-minute digital timer
 Child safety lock
 Residual heat indicator
 Boost function

- Specifications**
 Total power 7000W:
 Front left: ϕ 140mm, 1500/1800W (Boost)
 Rear left: ϕ 210mm, 2000/2300W (Boost)
 Front right: ϕ 210mm, 2000/2300W (Boost)
 Rear right: ϕ 140mm, 1500/1800W (Boost)

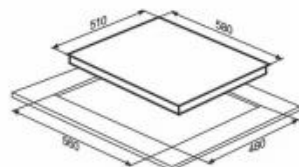

INDUCTION

Fastest & most efficient cooking

Heat is generated directly in the cooking vessel by magnetic induction so there is no heat transfer.

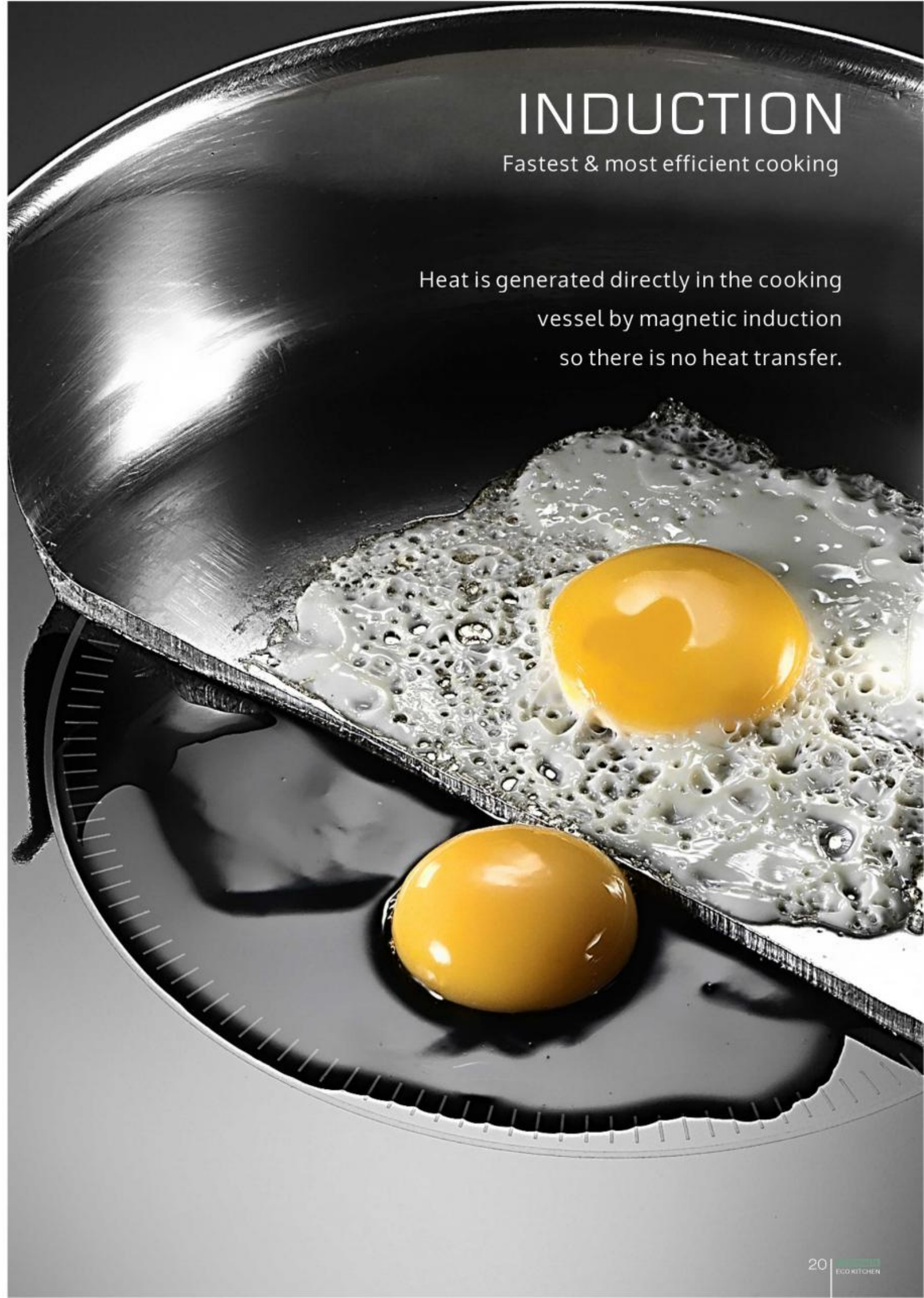



Newmatic

OVEN COLLECTION

Replicate the techniques of master chefs
to bring out the best in your cooking at home



NEWMATIC BUILT-IN OVEN



Triple glazed glass doors for complete safety & peace of mind.



Tangential Ventilation

The oven is limited to a manageable temperature that ensures durability of components and protects the surrounding furniture.



Soft Touch, Multi-angle Door

Special spring assisted hinges allow the door to be closed without abrupt slamming. The same hinges support the oven door to at any angle desired.



Cool Touch Door

Triple glazed glass doors make NEWMATIC oven completely safe to touch during cooking. An important consideration especially when there are curious little tots around the kitchen.

MULTI-FUNCTION SELECTOR



Force Air
Uses a combination of fan and bottom heat. This is ideal for anything that needs a crispy underside like pizzas, or speciality breads. It can also be used for one stage pastry such as lemon meringue pie, eliminating the need for blind baking.

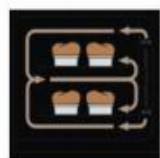

Bread baking
The bread baking temperature varies between 180 °C and 220 °C. This is ideally suited to baking crusty bread with an open texture. Up to three levels of bread can be baked at the same time.



Top/bottom heat
Providing conventional cooking heat sources at the top and bottom of the oven. Heat travels to the centre of the oven by natural conduction. This is ideal for baking pastries and scones.



Bottom heat
Providing heat from the bottom of the oven only, for more focused heat and control. This method is ideal for pizza bases and pastry cases where you need a crispy underside or bain-marie and casseroles.



Defrost
The fan will circulate air through the oven to speed up defrosting times. Ideal for delicate foods as well as fish and poultry.



Full surface grill
The grill element is situated in the oven roof. It is thermostatically controlled and will cycle on and off to maintain the required temperature.



Centre surface grill
You can use just the centre section of the grill for smaller quantities.



Roasting
The grill element cycles on and off alternately, and the fan distributes the heat produced by the grill. This method can reduce cooking times by 35% - 40% and is ideal for meats and poultry if you are after a rotisserie result.



Air fryer
The air fryer is the newest technology, it targets food with fast, super-heated air from every direction to take your food from frozen to golden in minutes with little to no oil!



FM6113T



- Features**
 65L built-in touch control multifunction oven
 Energy class A
 LCD display
 Aluminum Handle
 Total power 2200W
 220V 50Hz
 Triple coated glass door



Multifunction Oven with 11 Cooking Programs

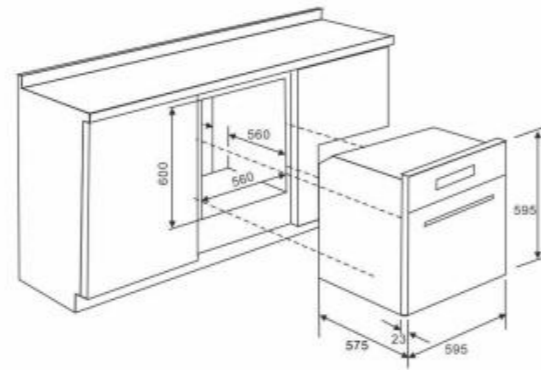

FE633

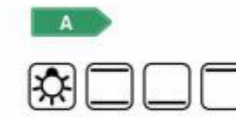

- Features**
 65L built-in electric oven
 Energy class A
 Aluminum Handle
 Total power 2200W
 220V 50Hz
 Double coated glass door
 One piece of grill



Electric Oven with 4 Cooking Programs

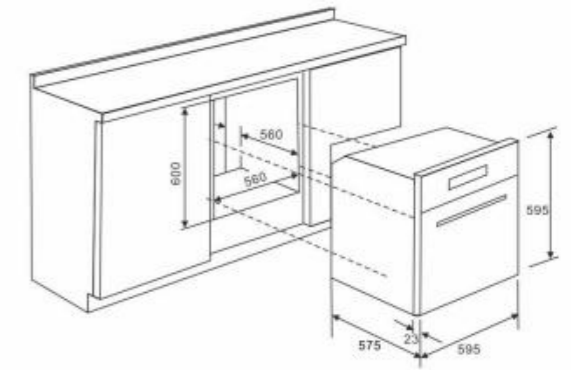

FM673



- Features**
 65L built-in electric oven
 Energy class A
 Mechanical timer
 Aluminium Handle
 Total power 2200W
 220V 50Hz
 Triple coated glass door

Multifunction Oven with 7 Cooking Programs

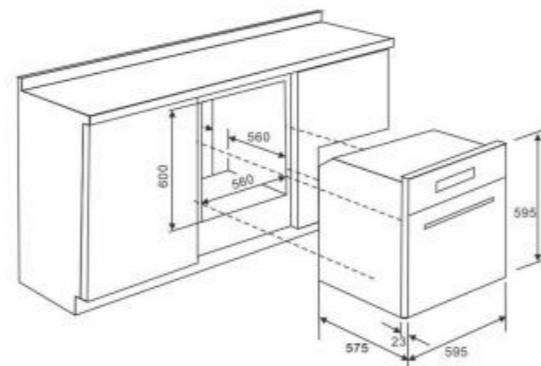

28L Built-in Microwave Oven

28EPS

- Features**
 Sensor touch control
 Microwave & Grill function
 Stainless steel cavity
 LED Display
 Electric auto open door

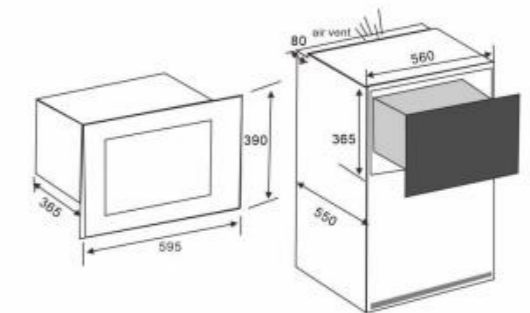



24cm Ultra Deep Bowl

SINK COLLECTION

Every wash an enjoyable moment

Newmatic

Enjoy the Exquisite Life

HANDCRAFTED DOUBLE BOWLS

- Made of high grade SUS304 material
- High quality seamless laser welding
- Luxurious brushed surface finish

SINK

Newmatic



NEWMATIC KITCHEN SINK



Topmount Kitchen Sink

Accessories



Item No.	Finish	Size
Single 45	Stainless Steel	φ450 x D180mm

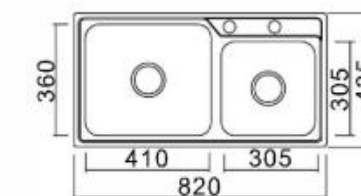

Topmount Kitchen Sink

Accessories



Options



Item No.	Finish	Size
Double 82	Stainless Steel	L820x W435 x D240mm

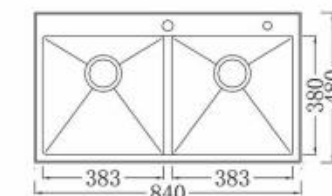

Topmount Handcrafted Kitchen Sink

Accessories



Item No.	Finish	Size
Double H84	Stainless Steel	L840x W480 x D230mm

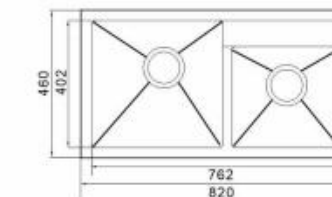

Topmount Black Quartz Kitchen Sink

Accessories



Item No.	Finish	Size
DOUBLE Q88	Black Quartz	L820x W460 x D210mm



HOT SALE

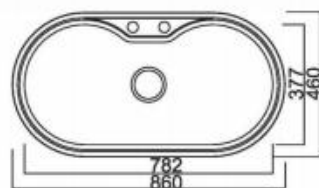

Accessories



A07 B11 D05 D18 P10 P11 C05

Topmount Kitchen Sink

Item No.	Finish	Size
Spring 86	Stainless Steel	L860x W460 x D230mm

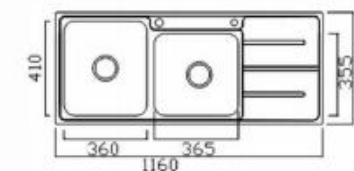

Topmount Kitchen Sink

Accessories



A07 B10

Options



D08C D28D P06 C05 P12

Item No.	Finish	Size
Double 116	Stainless Steel	L1160x W485 x D240mm

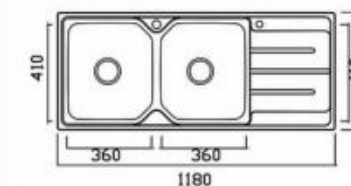

Topmount Kitchen Sink

Accessories



A07 B10

Options



D08C D29 C05 P12

Item No.	Finish	Size
Double 118	Stainless Steel	L1180x W500 x D240mm

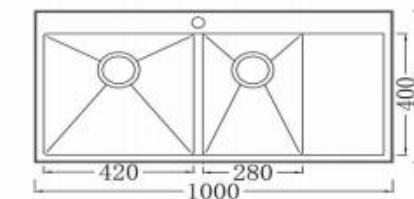

Topmount Kitchen Sink

Accessories



A07 B10



P17E P30E

Item No.	Finish	Size
Double H10	Stainless Steel	L1000x W500 x D230mm

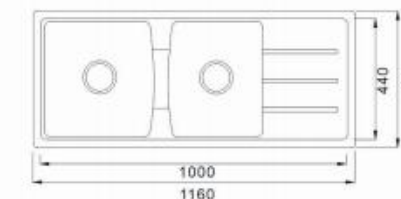

Topmount Black Quartz Kitchen Sink

Accessories



A31 B25

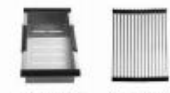

P17E P30E

Item No.	Finish	Size
Double Q116	Black Quartz	L1160x W500 x D210mm

UNDERMOUNT

TOPMOUNT



NEW ARRIVAL

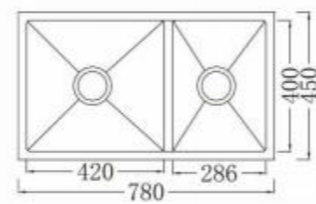

Undermount Handcrafted Kitchen Sink

Accessories



A07 B10

Item No.	Finish	Size
Double HU78	Stainless Steel	L780x W450 x D230mm



HIGH QUALITY

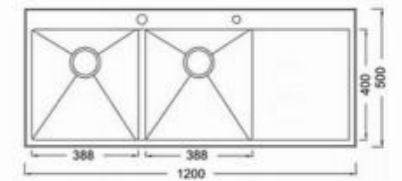

Topmount Handcrafted Kitchen Sink

Accessories



A07 B10 P17E P30E

Item No.	Finish	Size
Double H120	Stainless Steel	L1200x W500 x D230mm

KITCHEN TAP



T08MF



T08BG-MF



T14MF



T03C



T04MF



T15MF



T02M



T10MF

Transform Your Kitchen with NEWMATIC Advanced Pull-Out Basket



German Engineering at Its Best

Experience superior durability with our dual-wheel dampened guide rail, equipped with a cushioned rebound feature.



Maximize Your Cabinet Space

Turn cabinets into spacious warehouses! Multi-tiered storage suitable for wines, snacks, condiments, kitchen tools, and more.



90° Innovative Linkage

Convenient and user-friendly opening mechanism for easy access.



Stress-Free Load-Bearing

Robust and steady, our pull-out system ensures easy glide without straining, giving you peace of mind with every pull.



KITCHEN PANTRY BK7160

HARDWARE COLLECTION

Newmatic



SLIM DRAWER BASKET

ITEM NO.: BK.3405

Stainless Steel	L430 x W150 x H450mm	200mm



DOOR BASKET

ITEM NO.: BK.1202

Stainless Steel	L450 x W110 x H430mm	150mm



KITCHEN DRAWER BASKET

ITEM NO.: BK.2202

Stainless Steel	L430 x W360 x H440mm	400mm



SLIM KITCHEN BASKET

ITEM NO.: BK.2301

Stainless Steel	L440 x W110 x H520mm	150mm



KITCHEN DRAWER BASKET

ITEM NO.: BK.3401

Stainless Steel	L425 x W350 x H457mm	400mm



KITCHEN DRAWER BASKET

ITEM NO.: BK.2403

Stainless Steel	L430 x W110 x H440mm	150mm

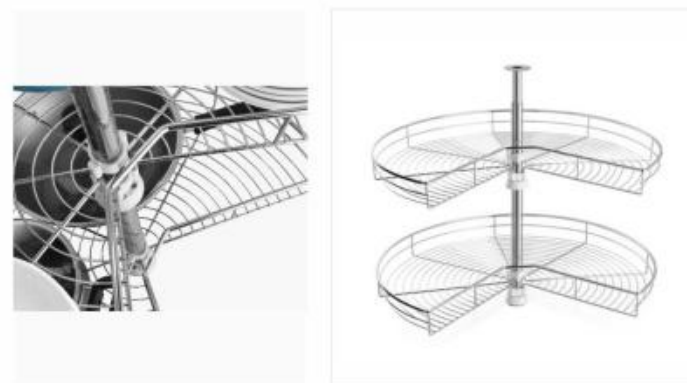

270° CIRCLE REVOLVING BASKET

ITEM NO.: BK.4127

Steel	φ715 x H(580-900)mm	800mm



SWING TRAYS

ITEM NO.: BK.4010

Steel	L425x W350x H457mm	400mm



S.S. CABINET DRAINING DISH RACK

ITEM NO.: BK.8010

304 Stainless Steel	L280 x W765 x H65mm	800mm



KITCHEN DRAWER BASKET

ITEM NO.: BK.3201 BK3202

Stainless Steel	L425 x W764 x H168mm	800mm

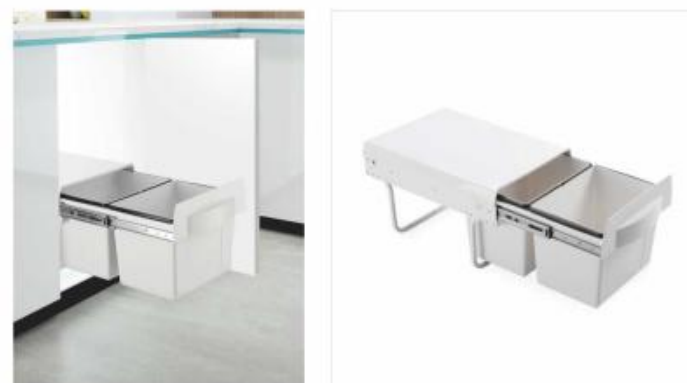

TRASH BINS

ITEM NO.: BK.9010

Plastic+ Iron	L510 x W340 x H430mm 20L x 2	400mm



MAGIC CORNER TRAY BASKET

ITEM NO.: BK.5080

		
Stainless Steel	L480 x W(860-960) x H560mm	900-1000mm

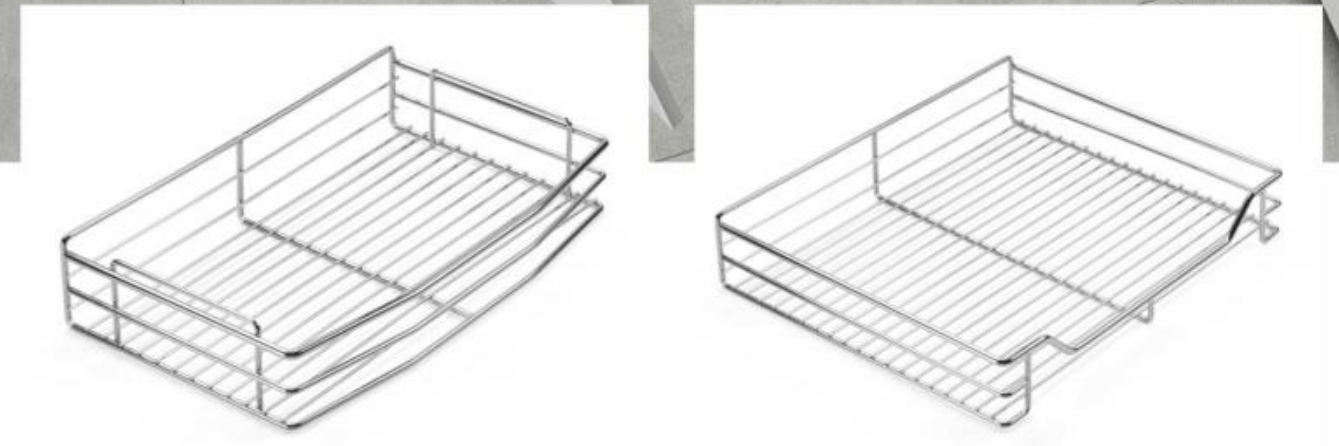

MAGIC CORNER WIRE BASKET

ITEM NO.: BK.5090

		
Steel	L480 x W(860-900) x H560mm	900-1000mm



TALL PULL-OUT PANTRY

ITEM NO.: BK.7130

		
Steel	L450 x W260 x H(1750-1950)mm	300mm(6Layers)



PULL-OUT PANTRY

ITEM NO.: BK.7145

		
Stainless Steel	L564 x W500 x H(1650-1950)mm	600mm(6Layers)



COUNTERTOP COLLECTION

Quartzite, born from sandstone, undergoes an intense metamorphic transformation through heat and pressure, emerging as a remarkably durable natural stone. Its unique recrystallization imparts a stunning sparkle. Boasting unparalleled strength and longevity, quartzite is the premier choice for countertops, marrying beauty with enduring quality.

20MM QUARTZITE



STAR WHITE QUARTZ

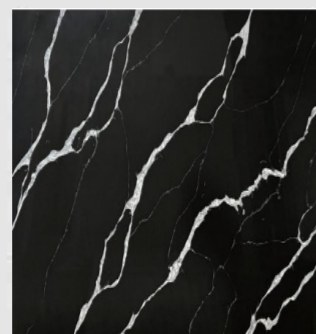

BLACK MARQUINA QUARTZ



CALACATTA QUARTZ



EARL WHITE QUARTZ

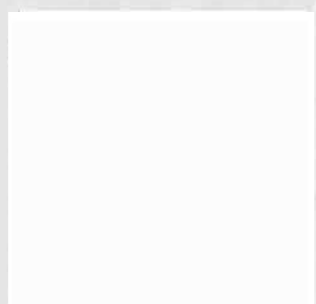

SUPER WHITE QUARTZ



INTERSTELLAR QUARTZ

12MM/20MM SINTERED STONE



ROMAN SINTERED STONE

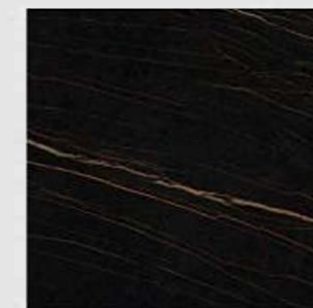

SLATE SINTERED STONE



TITANIUM SINTERED STONE



SHAKESPEARE SINTERED STONE



SCULPTURE SINTERED STONE



SPLASHBACKS

Newmatic

Splashbacks are expertly crafted beautiful glass tiles, constructed from tempered glass. They are specifically designed to be positioned behind a cooking hob, serving as aesthetically durable, easy to clean, protective barrier for the walls surrounding work surfaces.



Paint Splash Digital Printed

- 600x750x6mm
- 900x750x6mm



Rainbow Smoke on Black

- 600x750x6mm
- 900x750x6mm



Peppers and Chilli

- 600x750x6mm
- 900x750x6mm



Rainbow Wave

- 600x750x6mm
- 900x750x6mm



Dandelion Ballerinas On White

- 600x750x6mm
- 900x750x6mm



Red and White Wine

- 600x750x6mm
- 900x750x6mm



London Fashion on White

- 600x750x6mm
- 900x750x6mm



Newmatic

BUILDER SERIES

Hardworking & competitive priced products custom to the construction industry.

These models are manufactured in the same facility with the same quality standards but with simpler features that are easy to use & extremely durable.

Available on indent basis.



90cm Glass Island Hood

H95.9P

Features

- 90cm stainless steel island hood
- 3 speed push button control
- 5 layers washable aluminum grease filters
- Stainless steel seamless chimney

Specifications

- Lighting: LED lamp 2x2W
- Motor input power: 138W
- Air flow: 760m³/h
- Outlet diameter: ϕ 150mm
- Noise level: \leq 58dB(A)



90cm Stainless Steel Pyramid Wall Hood

HT33.9P

Features

- 90cm stainless steel wall hood
- 3 speed push button control
- 5 layers washable aluminum grease filters
- Stainless steel seamless technological design

Specifications

- Lighting: LED lamp 1x1.5W
- Motor input power: 75W
- Air flow: 550m³/hr
- Outlet diameter: ϕ 150mm
- Noise level: \leq 58dB(A)



60cm Stainless Steel Pyramid Wall Hood

HT33.6P

Features

- 60cm stainless steel wall hood
- 3 speed push button control
- 5 layers washable aluminum grease filters
- Stainless steel seamless technological design

Specifications

- Lighting: LED lamp 1x1.5W
- Motor input power: 75W
- Air flow: 550m³/hr
- Outlet diameter: ϕ 150mm
- Noise level: \leq 58dB(A)



60cm Stainless Steel Under Cabinet Hood

HT17.6P

Features
 60cm stainless steel under cabinet hood
 3 speed push button control
 3 layers washable aluminum grease filters

Specifications
 Lighting: LED lamp 1x1.5W
 Motor input power: 100W
 Air flow: 550m³/hr
 Outlet diameter: ϕ 150mm
 Noise level: \leq 58dB(A)

Options
 90 cm width is available.



90cm Stainless Steel Wall Hood

HT75.9P

Features
 90cm wall mounted hood with glass canopy
 3 speed push button control
 5 layers washable aluminum grease filters

Specifications
 Lighting: LED lamp 1x1.5W
 Motor input power: 75W
 Air flow: 760m³/hr
 Outlet diameter: ϕ 150mm
 Noise level: \leq 58dB(A)

Options
 60 cm width is available.



90cm Stainless Steel Wall Hood

HT61.9P

Features
 90cm wall mounted hood
 3 speed push button control
 5 layers washable aluminum grease filters

Specifications
 Lighting: LED lamp 1x1.5W
 Motor input power: 75W
 Air flow: 760m³/hr
 Outlet diameter: ϕ 150mm
 Noise level: \leq 58dB(A)

Options
 60 cm width is available.



60cm Built-in Gas Hob

PM640TX-1

Features
 304 stainless steel top plate
 Heavy duty cast iron trivets
 Battery ignition(1.5V)
 Flame failure device (FFD)
 Zinc alloy knob & spacer

Specifications
 Gas type: LPG
 Rated Heat:
 1x Triple ring burner 3.4kW
 2x Semi-rapid burner 1.8kW
 1x Auxiliary burner 1.0kW

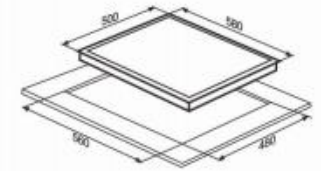

90cm Built-in Gas Hob

PM950TX-1

Features
 304 stainless steel top plate
 Heavy duty cast iron trivets
 Battery ignition(1.5V)
 Flame failure device (FFD)
 Zinc alloy knob & spacer

Specifications
 Gas type: LPG
 Rated Heat:
 1x Triple ring burner 3.4kW
 1x Rapid burner 2.4kW
 2x Semi-rapid burner 1.8kW
 1x Auxiliary burner 1.0kW

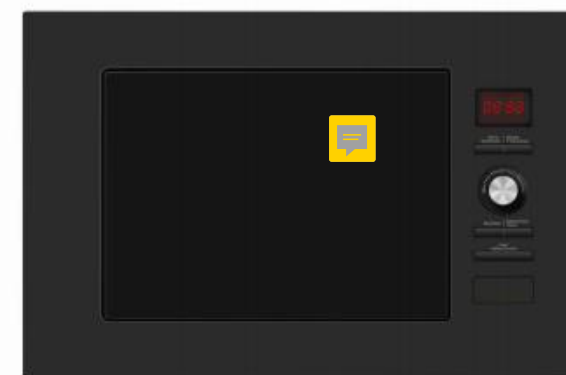
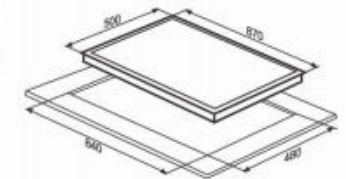

20L Built-in Microwave Oven

20EPM

Features
 Mechanical Control
 Microwave Function
 Digital Clock & Timer
 304 Stainless Steel Cavity, 20L
 Digital Clock Display
 LED Display

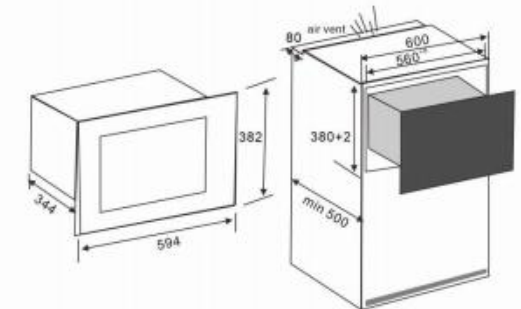

Newmatic Kitchen



Singapore

#06-13 Atrix Building Singapore 388409
Tel : 8883 8677
<https://www.newmatic.sg>

China

26-12 Dongle Huayuan Daliang Shunde Foshan
Guangdong China
<https://www.newmatic.com>

Tanzania

Mikocheni Light Industrial Area
ITV Junction Dar es Salaam Tanzania
Tel : 0764740972
<https://www.newmatic.co.tz>

Uganda

Plot No.84/88 7th street Industrial area,
Kampala Uganda
Tel: 0759736614
<https://newmatic-appliances.com>

Kenya

HQ / Lavington Showroom:
James Gichuru Road (Near Muthangari Police Station)
Tel: 0711477711
<https://www.newmatic.shop>

Mombasa Road Showroom:
Kellico Complex Nairobi Kenya
Tel: 0719331818

Kiambu Showroom:
Kiambu Road Nairobi Kenya
Tel: 0111913341

Kisumu Showroom:
The West End Mall Kisumu Kenya
Tel: 0743572321

Mombasa Showroom:
Amal Plaza Nyali Mombasa Kenya
Tel: 0768864596

Nakuru Showroom:
Lower K.S. Bedi Road, Kakuru Town, Kenya
Tel: 0715700800

Eldoret Showroom:
Eagle Hardware Distributors Kisumu Road Eldoret Kenya
Tel: 0717984418

Contact Us

Kenya, Tanzania, Uganda

The manufacturer declines responsibility for any accidents arising from self installation

